

Mounting

The blind hollow shaft of the rotary encoder is seated onto the measured shaft and fastened with a central screw. It is particularly important to ensure that the positive-locking element of the 1KA rotary encoder shaft securely engages the corresponding slot in the measured shaft. The stator is positioned for mounting via a centering diameter and fastened with two mounting screws. Use screws with material bonding anti-rotation lock (see *Mounting accessories*).



Further information:

For the customer-side mounting design, aluminum and steel are permissible materials for the customer-side shaft and stator.

In addition, comply with the material specifications and other material characteristics in the *Encoders for Servo Drives* brochure (ID 208922-xx).

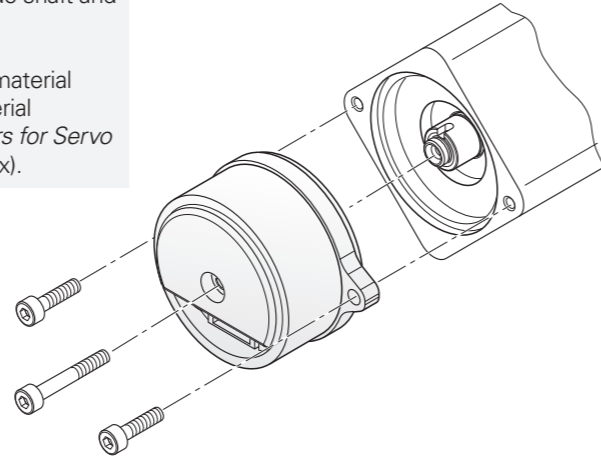

Integrated temperature evaluation

This rotary encoder features a temperature sensor integrated into the encoder electronics and an evaluation circuit for an external temperature sensor. In both cases, the respective digitized temperature value is transmitted purely serially via the EnDat protocol. Please bear in mind that neither the temperature measurement nor the transmission of the temperature value is safe in terms of functional safety. With regard to the internal temperature sensor (FID 0x21 SENSOR_TEMP_INT), the rotary encoder supports the two-stage cascaded signaling of a temperature exceedance. It consists of an EnDat warning and an EnDat error message. In compliance with the EnDat specification, when the temperature reaches the warning threshold for temperature exceedance of the internal temperature sensor, an EnDat warning is issued (HPF.STATUS.W "collective warning bit"). In addition, bit 26 (W10) "Temperature warning threshold exceeded" is set in the LPF with the FID=ERRMSG. This warning threshold for the internal temperature sensor is stored in the parameter SET.tempWarnLevel and can be individually adjusted. A device-specific default value is saved here before shipping. The temperature measured by the internal temperature sensor is higher by a device-specific and application-specific amount than the temperature at measuring point M1, as shown in the dimension drawing.

The encoder features a further, albeit non-adjustable trigger threshold for the EnDat error message (HPF.STATUS.F "collective error bit"). In addition, bit 8 (A8) "Permissible ambient conditions exceeded" is set in the LPF with the FID=ERRMSG. This trigger threshold may vary depending on the encoder model and is stated in the specifications. HEIDENHAIN recommends adjusting the warning threshold based on the application such that this threshold is sufficiently below the trigger threshold for the "Temperature exceeded" EnDat error message. Fulfillment of the encoder's intended use requires adherence to the operating temperature at measuring point M1.

Mounting accessories

Screws

Screws (central screw, mounting screws) are not included in delivery. They can be ordered separately.

ECN 1119/EQN 1131	Screws ¹⁾		Quantity
Central screw for shaft fastening	ISO 4762-M3x25-8.8-MKL	ID 202264-86	10 or 100
Fastening screw for flange	ISO 4762-M3x10-8.8-MKL	ID 202264-87	20 or 200

¹⁾ With coating for material bonding anti-rotation lock

Please note the information on screws from HEIDENHAIN in the *Encoders for Servo Drives* brochure, under *Screws with material bonding anti-rotation lock* in the chapter *General mechanical information*.

Mounting aid

To avoid damage to the cable, use the mounting aid to connect and disconnect the cable assembly. Apply pulling force only to the connector of the cable assembly and not to the wires.

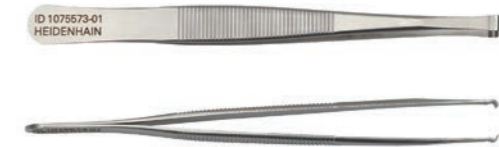

ID 1075573-01

Mounting aid

For turning the encoder shaft from the rear. This facilitates finding the positive-locking connection between the encoder and the measured shaft.



ID 821017-03

EnDat 3 adapter

Adapter for connecting an encoder with EnDat 3 (E30-R2) to the PWM 21





ID 1317260-01

For further mounting information and mounting aids, please refer to the relevant mounting instructions and the *Encoders for Servo Drives* brochure. The mounting arrangement can be checked with the PWM 21 and ATS software. For selection of the software, please contact HEIDENHAIN.

Electrical connection

Cables

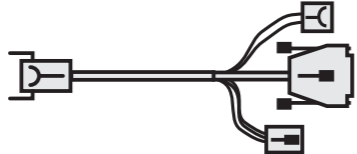
ETFE encoder cable inside the motor \varnothing 1.8 mm $2 \times 0.15 \text{ mm}^2$, without shield and with ETFE wires \varnothing 2.2 mm $2 \times 0.15 \text{ mm}^2$ for a temperature sensor; $A_P = 0.15 \text{ mm}^2$		
15-pin PCB connector (female) and unassembled cable end, with two twisted ETFE single wires (communication) and two ETFE single wires (length: 0.10 m) with heat shrink tubing (temperature sensor)		1302347-xx
15-pin PCB connector (female) and 8-pin M12 SpeedTEC angle flange socket (male), with two twisted ETFE single wires (communication) and two ETFE single wires (length: 0.10 m) with heat shrink tubing and a 2-pin connector (male) for a temperature sensor		1279930-xx
PUR adapter cable \varnothing 9.3 mm with external shield; $4 \times 0.5 \text{ mm}^2$ (power wires) $2 \times 0.34 \text{ mm}^2$ (brake wires, shielded) $2 \times 0.14 \text{ mm}^2$ (communication wires, shielded); $A_P = 0.14 \text{ mm}^2$		
8-pin M12 SpeedTEC straight connector (female), 3-pin header connector (power), 4-pin header (brake wires), and 15-pin D-sub connector (male) (communication)		1279881-xx





The connecting element must be suitable for the maximum clock frequency used.

Note for safety-related applications:

- Conformity with the EMC Directive must be ensured in the complete system!

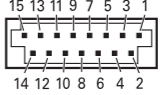
SpeedTEC is a registered trademark of TE Connectivity Industrial GmbH.

Pin layout of ECI, EQI

8-pin M12 SpeedTEC angle flange socket 		15-pin PCB connector 	
Encoder		Other signals	
Power supply / Serial data transfer		Other signals	
 8	A	B	/
 15	9	10	5
 2	-	-	2
	P_SD+ ¹⁾	P_SD- ¹⁾	T+ ²⁾
	Violet	Yellow	Brown

Motor						
Brake			Power			
 8	C	D	1	2	3	4
	Brake +	Brake -	U	V	W	PE

¹⁾ Power supply and data: P_SD+ includes U_P ; P_SD- includes 0 V

²⁾ Connections for external temperature sensor; evaluation optimized for a KTY 84-130, PT 1000, and other sensors; (see *Temperature measurement in motors* in the *Encoders for Servo Drives* brochure)

Cable shield connected to housing; **U_P** = Power supply voltage

Vacant pins or wires must not be used!

Note on safety-related applications: only completely assembled HEIDENHAIN cables are qualified for this. Do not modify cables or exchange their connectors without first consulting with HEIDENHAIN Traunreut!

SpeedTEC is a registered trademark of TE Connectivity Industrial GmbH.

HEIDENHAIN

DR. JOHANNES HEIDENHAIN GmbH

Dr.-Johannes-Heidenhain-Straße 5

83301 Traunreut, Germany

 +49 8669 31-0

 +49 8669 32-5061

info@heidenhain.de

www.heidenhain.com

This Product Information document supersedes all previous editions, which thereby become invalid. The basis for ordering from HEIDENHAIN is always the Product Information document edition valid when the order is made.



Further information:

To ensure proper use, comply with the requirements described in the following documents:

- Brochure: *Encoders for Servo Drives* 208922-xx
- Brochure: *Cables and Connectors* 1206103-xx
- Brochure: *Interfaces of HEIDENHAIN Encoders* 1078628-xx
- Product Information doc.: *HMC 2* 1305512-xx
- Technical Information doc.: *EnDat 3* 1305415-xx
- Mounting Instructions: *ECl 1119, EQI 1131* 1306491-xx
- EnDat 3 Application Conditions for Functional Safety 3000003-xx
- Supplementary Application Conditions for EnDat 3 for Step Monitoring (SIL 3, PL e) 1277016-xx