



# HEIDENHAIN



Product Information

## **TD 110**

Tool Breakage Detector for  
Machine Tools

# TD 110 tool breakage detector



## TD 110

The TD 110 tool breakage detector checks for complete tool breakage on end mills and drills made of HSS or carbide. As the tool passes by, the sensor can detect whether the tool still has a cutting edge of more than 2 mm.

## Benefits

- Maintenance-free sensor for reducing non-productive time for breakage inspection
- Cooling lubricant and lightly contaminated tools are tolerated
- Universally retrofittable thanks to standard interfaces for tool touch probes

## Application

The tool breakage detector can be placed in the work envelope such that it is quick and easy to reach during the tool change. The inductive sensor can detect tools as they pass by while they are spinning at their operational speed, or at least at 1000 rpm. Thanks to its rapid scanning

technology, even very small tools made of HSS steel and carbide are detected. The breakage detector can generate either a floating or an HTL switching signal. The control can evaluate this switching signal via standard instruction sets. In addition, an LED indicates whether a tool has been detected.

## Example: detection of complete tool breakage

The tool passes the breakage detector on a linear path, and the spindle must be rotating at a speed comparable to machining speed. If no switching signal is received, meaning that a broken tool has been detected, then the control can react accordingly.

## Retrofitting on TNC controls

The tool breakage detector can be connected to the X113 input of a PLB, UEC or UMC via the connecting cables for the TT 160 tool touch probe.

Our Service department provides optimal support for the operation of HEIDENHAIN controls, including cycles for breakage detection that can be added via TNCremo. Please contact the HEIDENHAIN Service department:

Remote support  
service.nc-pgm@heidenhain.de  
ID 1369787-35

## Connection to other CNC controls

The HTL switching signals and the floating outputs can be used for the connection to the PLC or to other IOs of nearly every CNC control (support from the machine manufacturer may be necessary). For detailed descriptions of the interfaces, see the *Touch Probes for Machine Tools* brochure.

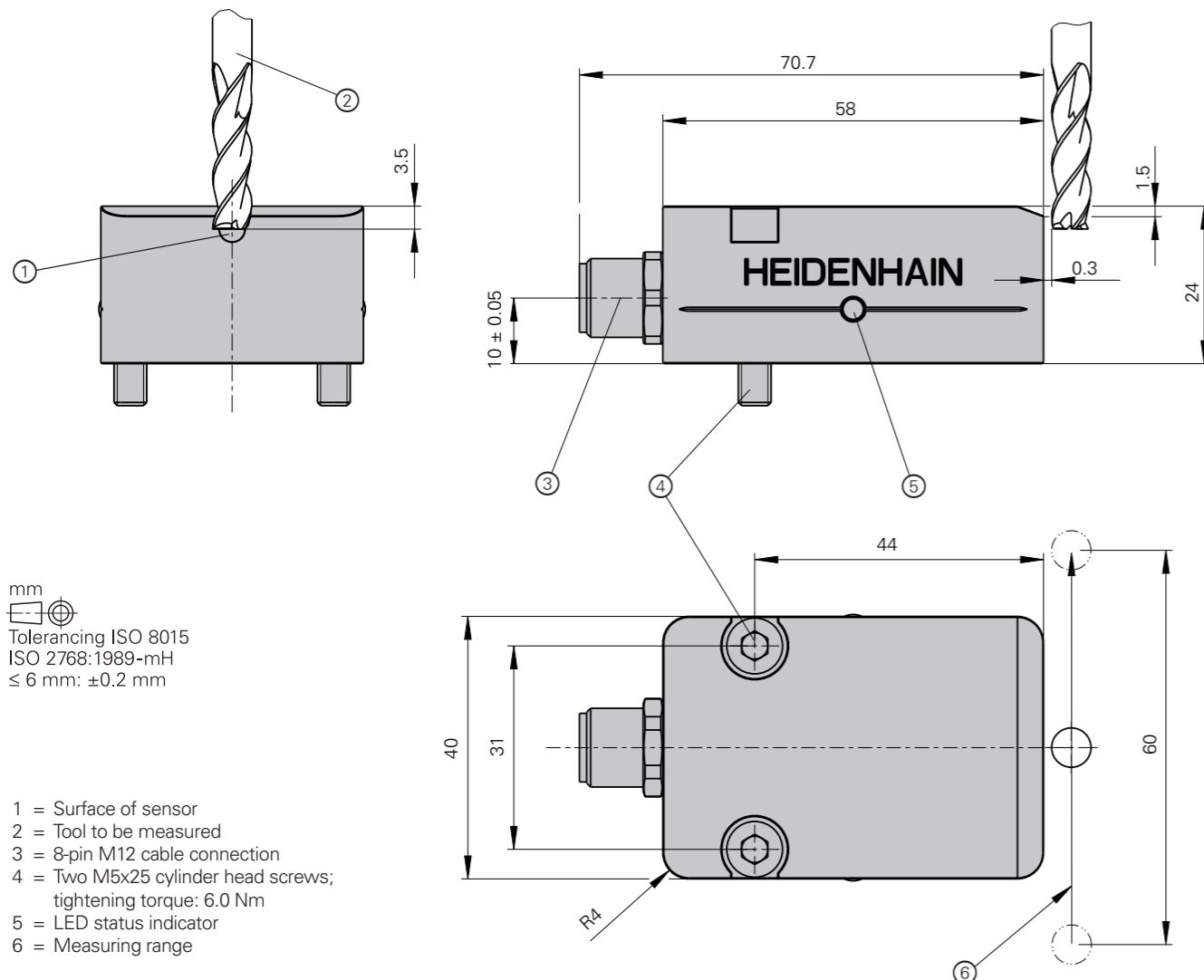

mm  
Tolerancing ISO 8015  
ISO 2768:1989-mH  
≤ 6 mm: ±0.2 mm



- 1 = Surface of sensor
- 2 = Tool to be measured
- 3 = 8-pin M12 cable connection
- 4 = Two M5x25 cylinder head screws; tightening torque: 6.0 Nm
- 5 = LED status indicator
- 6 = Measuring range

Specifications	TD 110
Type of mounting	Mounting holes
Electrical connection	8-pin M12 flange socket
Supply voltage	10 V to 30 V
Output signal	HTL (switching signal S, $\bar{S}$ ) Floating switching outputs (NC, NO)
Cable length	≤ 30 m
Vibration 55 Hz to 2000 Hz Shock 6 ms	≤ 200 m/s <sup>2</sup> (EN 60068-2-6) ≤ 300 m/s <sup>2</sup> (EN 60068-2-27)
Operating temperature	10 °C to 50 °C
Storage temperature	-20 °C to 70 °C
Protection rating	IP66/68





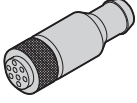
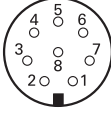

Supported tools	TD 110
Type	End mills, drills, taps, thread formers, ball-nose cutters, radius cutters
Material	HSS   Carbide
Minimum diameter for nominal scanning distance	0.4 mm
Minimum rotational speed	1000 rpm (recommended)
Feed rate	Rapid traverse (recommended)
Operating distance	≤ 0.5 mm (nominal: 0.3 mm)
Minimum tooth lengths	2 mm
L-OFFSET	Corner radius or corner chamfer, if > 1 mm
Breakage criteria	<ul style="list-style-type: none"> <li>• Complete tool breakage: 2 mm (+ L-OFFSET)</li> <li>• No breakage of individual teeth or cutting inserts</li> </ul>

# Electrical connection

## Pin layout

8-pin M12 connector (female)								
								
	<b>2</b>	<b>7</b>	<b>3</b>	<b>4</b>	<b>1</b>	<b>5</b>	<b>6</b>	<b>8</b>
	<b>U<sub>P</sub></b>	<b>0V</b>	<b>S</b>	<b><math>\bar{S}</math></b>	<b>B</b>	<b>Trigger NO</b>	<b>Trigger NC</b>	<b>Trigger 0V</b>
	Blue	Violet	Gray	Pink	White	White/Green	Yellow	Brown/Green

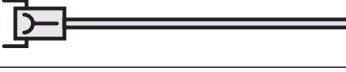
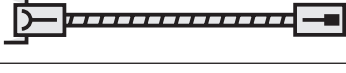
## Adapter cable and connecting cables

1 x (4 x 0.16 mm <sup>2</sup> ) + 4 x 0.34 mm <sup>2</sup>		∅ 6 mm	∅ 10 mm
<b>Adapter cable</b> with 8-pin M12 connector (female) and 15-pin, 3-row D-sub connector (male) (PLB X113)		1070794-xx <sup>1)</sup>	–
<b>Connecting cable</b> with 8-pin M12 connector (female) and 8-pin M12 coupling (male)		368330-xx	–
<b>Connecting cable</b> with 8-pin M12 right-angle connector (female) and 8-pin M12 coupling (male)		373289-xx	–
<b>Connecting cable</b> with 8-pin M12 right-angle connector (female) and unstripped cable end		606317-xx <sup>2)</sup>	–
<b>Connecting cable</b> with 8-pin M12 connector (female) and unstripped cable end		634265-xx <sup>2)</sup>	–
<b>Connecting cable</b> with 8-pin M12 connector (female) and 8-pin M12 coupling (male)		–	660042-xx
<b>Connecting cable</b> with 8-pin M12 connector (female), partial protective armor and stripped cable end		–	1083190-xx <sup>2)</sup>
<b>Connecting cable</b> with 8-pin M12 right-angle connector (female) and 8-pin M12 coupling (male)		–	1395683-xx

8-pin M12 wall duct

1142270-01

<sup>1)</sup> For connection to the PLB 62xx, UEC, UMC

<sup>2)</sup> Fanuc/Siemens/Mitsubishi/Mazak

# HEIDENHAIN

**DR. JOHANNES HEIDENHAIN GmbH**

Dr.-Johannes-Heidenhain-Straße 5

**83301 Traunreut, Germany**

☎ +49 8669 31-0

☎ +49 8669 32-5061

info@heidenhain.de

[www.heidenhain.com](http://www.heidenhain.com)

This Product Information document supersedes all previous editions, which thereby become invalid. The basis for ordering from HEIDENHAIN is always the Product Information document edition valid when the order is placed.

### More information:

Comply with the requirements described in the following documents to ensure correct and intended operation:

- Brochure: *Touch Probes for Machine Tools*
- Brochure: *Cables and Connectors*

1113984-xx

1206103-xx